

Knockonwood

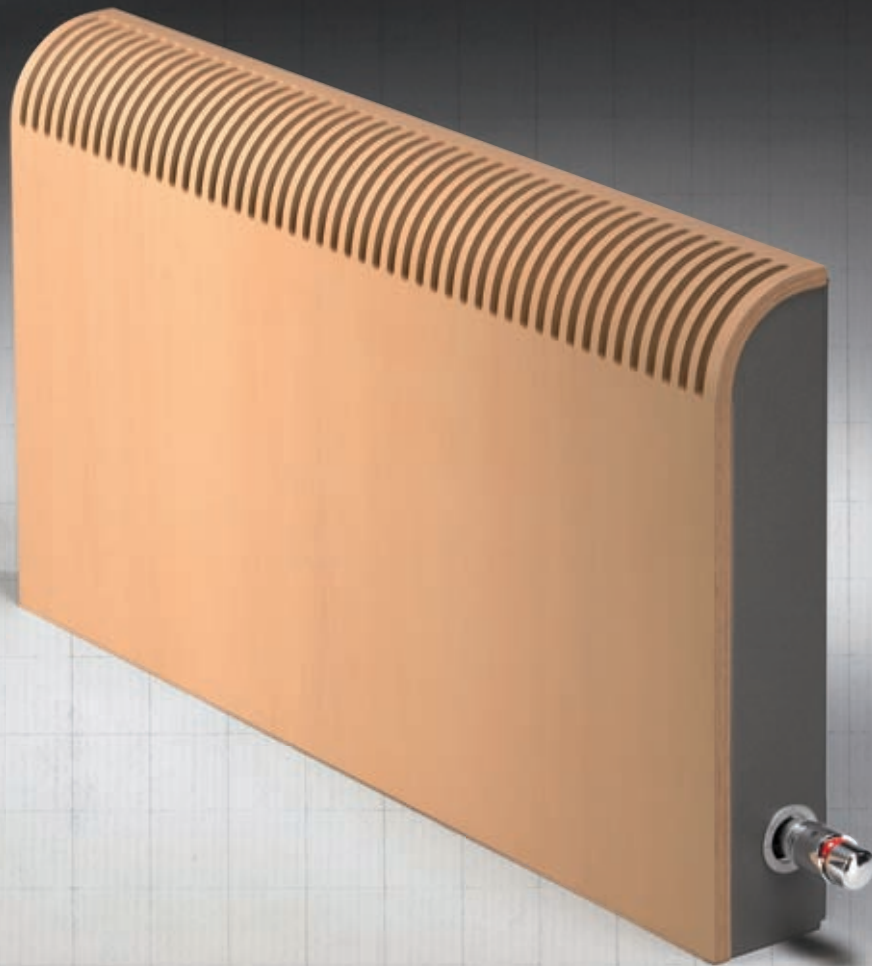

design award
winner
2003



Mixed Sources
Product group from well-managed
forests and other controlled sources

Cert no. GFA-COC-1215
www.fsc.org
© 1996 Forest Stewardship Council

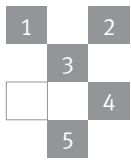

- 1.Oak natural
- 2.Zebrano
- 3.Zebrano
- 4.Oak bleached
- 5.Mahogany

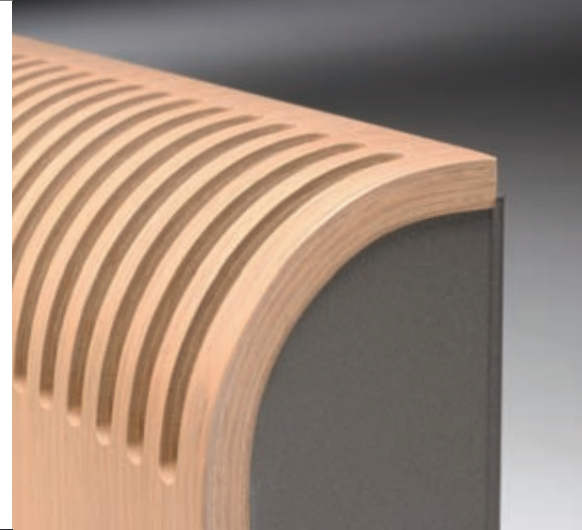



Warm power, noble wood

Imposing, surprising, innovative, confronting. Knockonwood is the very first radiator made of wood. The beautifully designed simple yet elegant covering has been finished with the noblest veneer. Durable wood that curves gracefully along the wall. Knockonwood's warm power radiates from its Low-H₂O core, which guarantees energy savings and a higher warmth output. Available in 9 different types of wood.

Casing

- The wooden covers are finished with a scratch-resistant polyurethane varnish, gloss degree 40%. High UV resistance.
- Price category 1:
 - Oak natural
 - Beech natural
 - Maple natural
 - Zebrano natural
- Price category 2:
 - Oak bleached
 - Beech bleached
 - Mahogany
 - Oak wenge-coloured
 - Walnut
- Metal parts: sandblast grey metallic (001)
- The valve and its connections are concealed within the standard casing.
- The surface temperature of the casing stays safe to touch, even at a water temperature of 90°C. Complies with the safety requirement DHSS DN4.
- The casing can be removed in its entirety for cleaning and maintenance.
- a 10 year guarantee

Low-H₂O heat exchanger

- of pure copper and aluminium, totally non-corrosive
- a 30 year guarantee
- pressure tested: 20 bar
- standard with extended air vent with transparent synthetic drain tube.
- with dirt-repellent and dust-proof lacquer in graphite grey (RAL 7024)
- high heat output achieved with normal and lower flow temperatures
- efficient: rapid heating up speed due to super low water content
- the optimal combination of convection and radiation

High efficiency boiler combination

Thanks to its low water content and high coefficient of heat conduction for low flow temperatures, the Knockonwood, with its modern Low-H₂O element, is ideal to use in combination with high efficiency boilers and/or condensing technology.

Twin Power, DBE or Oxygen?

Knockonwood is also available

- as DBE or Oxygen radiator: see price list "Top performers".
- with the super-powered Twin heat exchangers. The boiler temperature is on average 15% lower for equivalent radiator dimensions!

Knockonwood_Dimensions



KNOW_Knockonwood Wall

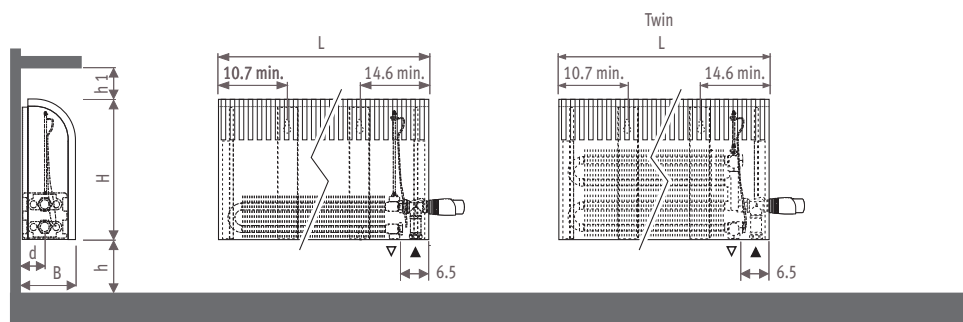

Dimensions in cm

Type	B	d	h min*	h1 min*
06	10.8	4.6	10	5
10-11	12.8	5.2	10	5
15-16	17.8	7.7	12	5

* Smaller dimensions can decrease output.

Connections

Jaga Comap valve to the wall

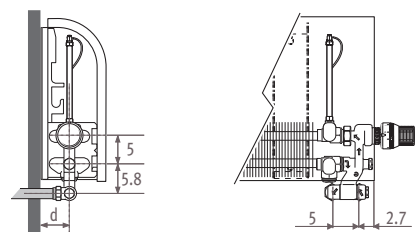

Jaga Comap valve to the floor

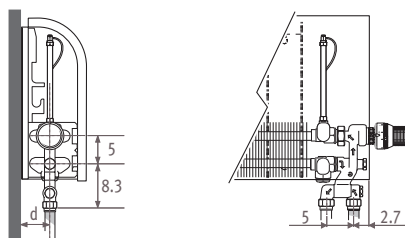

The valves offered by Jaga are totally concealed within the standard casing. Detailed info: see Connection sets and valves.

Jaga Pro valve to the wall

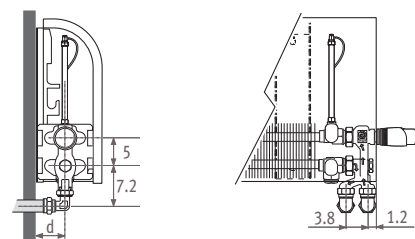

Jaga Pro valve to the floor

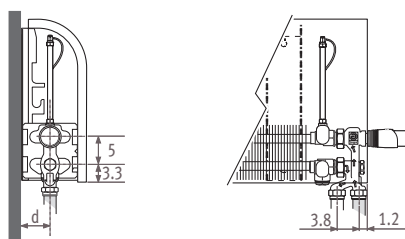

Jaga valve to the wall

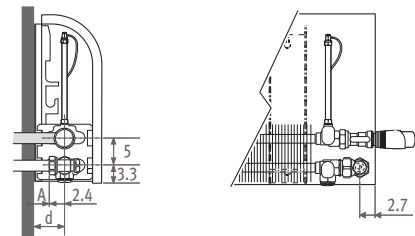

Jaga valve to the floor

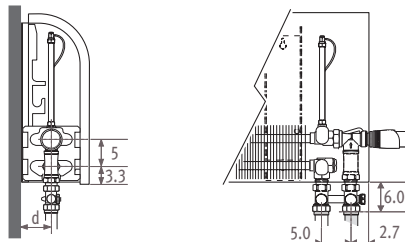

Jaga type 6 valve to the wall

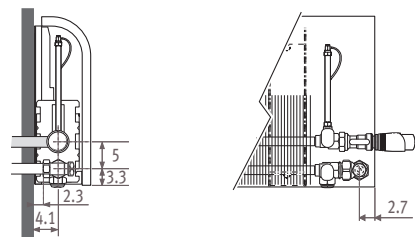

The Jaga type 6 valve: with short connection distance, special for Knockonwood type 06 connection to the wall. See p. 167/175.

Type	d	A
06	4.6	1.8
10-11	5.2	2.9
15-16	7.7	5.3



Knockonwood_Options

Top valve _____

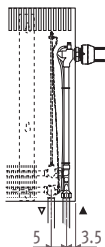

When ordering a top valve, add to the code of the Knockonwood /30 (top left) or /60 (top right).
Ex.: KNOW. 030 060 06.xxx/60

DBE & Oxygen version _____

DBE: the smallest and most powerful radiator.
Oxygen: for healthy heat and clean air.
See price list "Top performers".

CODE		H casing	€
5090.1300101	right	30	
5090.1300102	left	30	
5090.1300600	right and left	55	
5090.1301000	right and left	80	

Thermostatic head not included: see Connection sets & valves page 178-179.

Brush _____

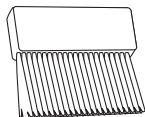

For easy cleaning of the underside of the Low-H₂O heat exchanger without detaching the casing.

CODE	€
5090.001	

Fixing calorimeter holder _____

See Special Products.



EURO NORM
EN 442

Output measured in accordance with EN442, at a water temperature of 75/65°C and a room temperature of 20°C (ΔT=50).

	Page
Connection sets & valves	163
Colours	270
Parts	203
Technical info	239
Correction factors	240
Product descriptions	246





Knockonwood_Wall mounted model

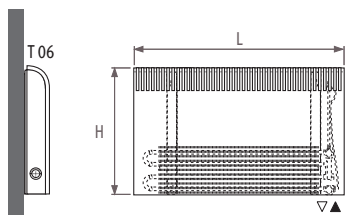

Standard delivery

- complete casing in one piece with wooden cover
- Twin Low-H₂O heat exchanger type 08
- wall brackets
- fixing kit
- extended air vent 1/8"
- drain cock 1/2"

Connection

- standard connection: bottom end left or right, valve position 20 or 70
- for option top valve, add to the code of the Knockonwood /30 (top left) or /60 (top right)
- ex.: KNOW. 030 060 06.xxx/60
- for remote controlled valve: see Special products

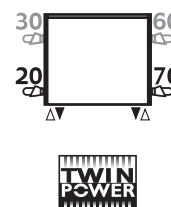

Type 06

code height length type wood
ORDERING CODE: KNOW. 030 060 06. xxx

H		L 060	080	100	120	140	180	220
030	75/65/20	416	554	693	832	970	1247	1525
	90/70/20	543	723	904	1085	1265	1626	1989
	cat. 1 €							
	cat. 2 €							
055	75/65/20	554	739	924	1109	1294	1663	2033
	90/70/20	720	961	1201	1442	1683	2162	2643
	cat. 1 €							
	cat. 2 €							
080	75/65/20	645	860	1075	1290	---	---	---
	90/70/20	836	1115	1393	1672	---	---	---
	cat. 1 €							
	cat. 2 €							

Category 1: Oak natural (700)
Beech natural (720)
Maple natural (760)
Zebrano natural (740)

Category 2: Oak bleached (701)
Beech bleached (721)
Mahogany (710)
Oak wenge-coloured (702)
Walnut (780) - extended delivery time

Knockonwood_Wall mounted model

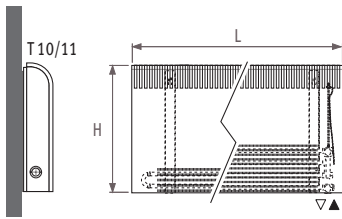

Standard delivery

- complete casing in one piece with wooden cover
- Low-H₂O heat exchanger type 10 or Twin type 11
- wall brackets
- fixing kit
- extended air vent 1/8"
- drain cock 1/2"

Connection

- standard connection: bottom end left or right, valve position 20 or 70
- for option top valve, add to the code of the Knockonwood /30 (top left) or /60 (top right)
- ex.: KNOW. 030 060 10.xxx/60
- for remote controlled valve: see Special products

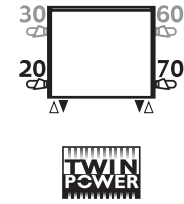

Type 10								Type 11								
								ORDERING CODE: KNOW.								
								code height length type wood								
H	L							H	L							
	060	080	100	120	140	180	220		060	080	100	120	140	180	220	
030	75/65/20	452	603	754	905	1056	1357	1659	75/65/20	515	687	859	1031	1203	1546	1890
	90/70/20	589	786	983	1180	1376	1769	2162	90/70/20	679	906	1132	1359	1586	2038	2492
	cat. 1 €								cat. 1 €							
	cat. 2 €								cat. 2 €							
055	75/65/20	660	880	1100	1320	1540	1980	2420	75/65/20	718	958	1197	1436	1676	2155	2633
	90/70/20	853	1137	1422	1706	1990	2559	3128	90/70/20	942	1256	1570	1883	2198	2826	3453
	cat. 1 €								cat. 1 €							
	cat. 2 €								cat. 2 €							
080	75/65/20	778	1037	1296	1555	75/65/20	845	1127	1409	1691
	90/70/20	997	1329	1661	1993	90/70/20	1102	1470	1838	2206
	cat. 1 €								cat. 1 €							
	cat. 2 €								cat. 2 €							

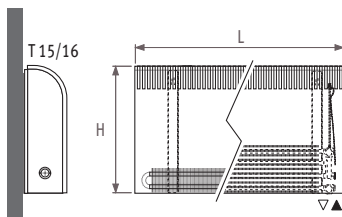

Standard delivery

- complete casing in one piece with wooden cover
- Low-H₂O heat exchanger type 15 or Twin type 16
- wall brackets
- fixing kit
- extended air vent 1/8"
- drain cock 1/2"

Connection

- standard connection: bottom end left or right, valve position 20 or 70
- for option top valve, add to the code of the Knockonwood /30 (top left) or /60 (top right)
- ex.: KNOW. 030 060 15.xxx/60
- for remote controlled valve: see Special products

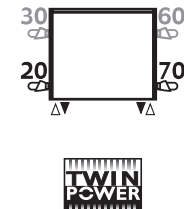

Type 15								Type 16								
								ORDERING CODE: KNOW.								
								code height length type wood								
H	L							H	L							
	060	080	100	120	140	180	220		060	080	100	120	140	180	220	
030	75/65/20	689	919	1149	1379	1609	2068	2528	75/65/20	752	1002	1253	1504	1754	2255	2757
	90/70/20	896	1195	1495	1794	2093	2690	3288	90/70/20	988	1316	1646	1975	2304	2962	3621
	cat. 1 €								cat. 1 €							
	cat. 2 €								cat. 2 €							
055	75/65/20	1001	1335	1669	2003	2337	3004	3672	75/65/20	1063	1418	1772	2126	2481	3190	3898
	90/70/20	1289	1720	2150	2580	3011	3870	4730	90/70/20	1392	1857	2321	2785	3249	4178	5105
	cat. 1 €								cat. 1 €							
	cat. 2 €								cat. 2 €							
080	75/65/20	1165	1553	1941	2329	75/65/20	1288	1718	2147	2576
	90/70/20	1487	1982	2477	2972	90/70/20	1682	2244	2804	3365
	cat. 1 €								cat. 1 €							
	cat. 2 €								cat. 2 €							

Category 1: Oak natural (700)
Beech natural (720)
Maple natural (760)
Zebrano natural (740)

Category 2: Oak bleached (701)
Beech bleached (721)
Mahogany (710)
Oak wenge-coloured (702)
Walnut (780) - extended delivery time

