

Iguana Circo Pillar cover

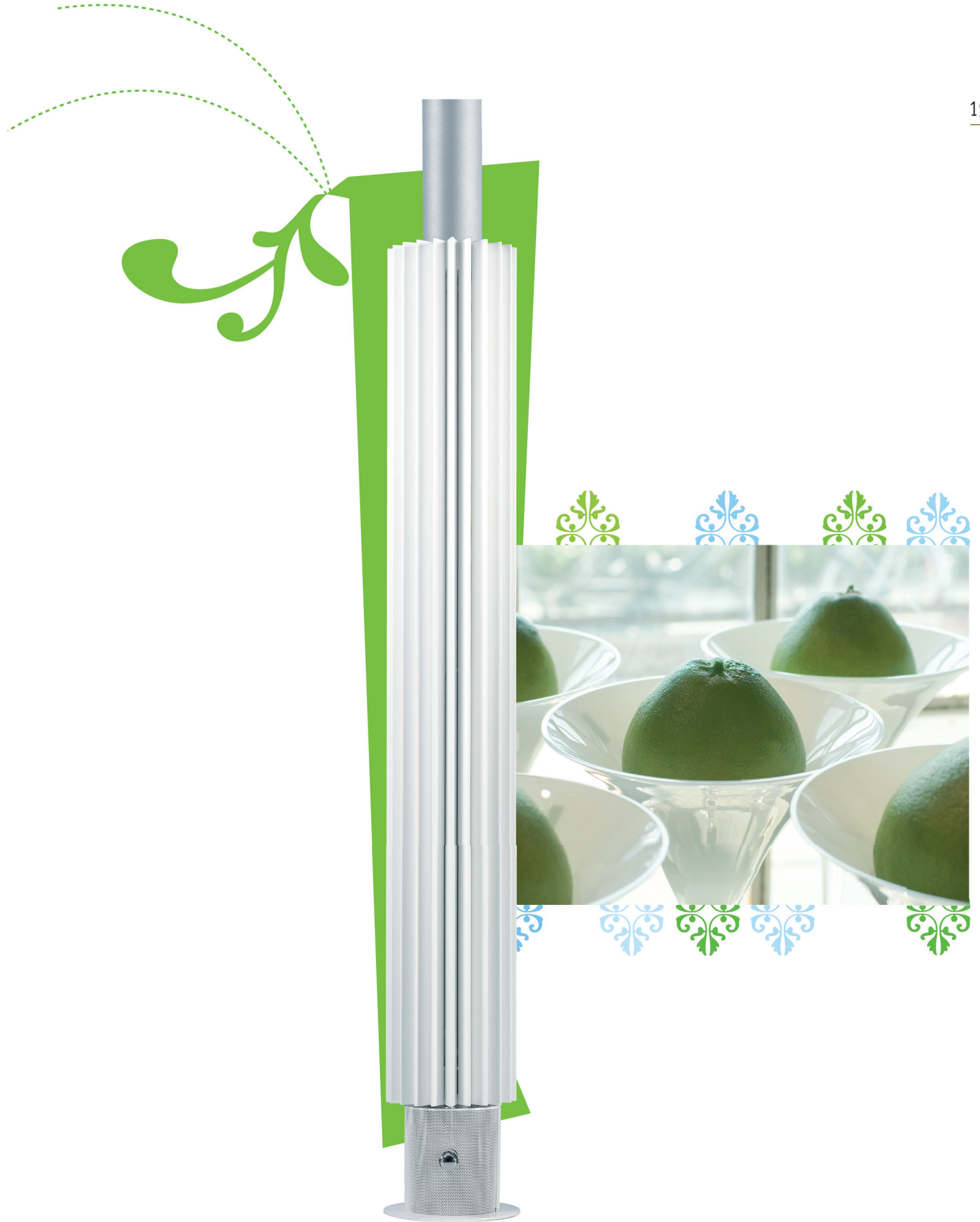

Iguana Circo Pillar cover

Dimensions

CIRP_Circo Pilar

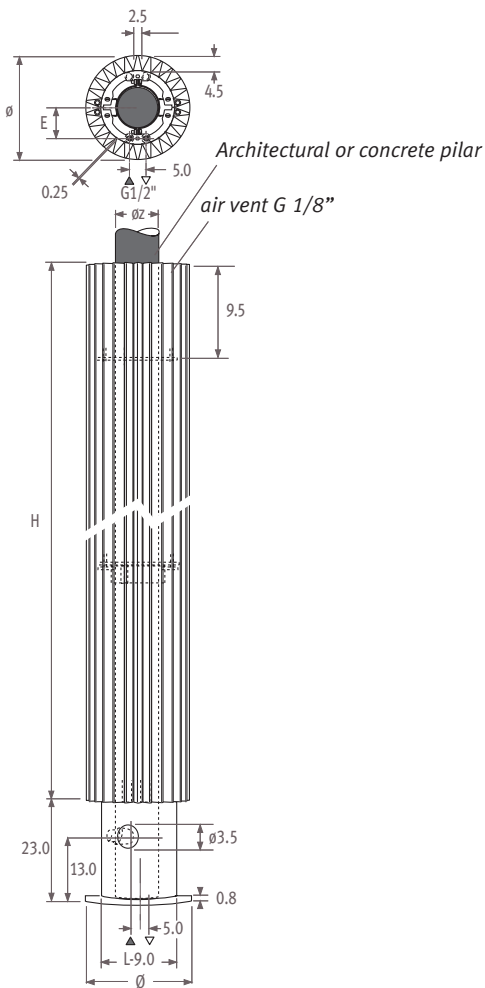

Position flow and return pipe

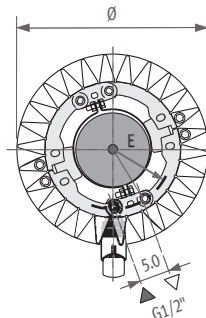
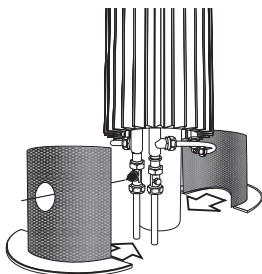

Standard delivery:
guard and connection set with thermostatic valve and lockshield included.
Sleeve couplings for connection sets with guard see page 209.

Dimensions in cm

Ø	27.8	31.3	34.8
E	7.5	9.4	11.3
ØZ	11.0	12.5	16.0

Connections

Two pipe



Standard connection

Code MM

Please note:
With the guard the standard flow is on the left. If a right hand flow is required please amend the code suffix using MM/CR

Notice

To guarantee the output of the Iguana models and to limit the pressure drop, Jaga recommends the use of tube diameter 16/2, 18/1 or 18/2.

Dimensions options

Table

Ø	27.8	31.3	34.8
L	66.0	73.0	80.0
D	50.0	55.0	60.0

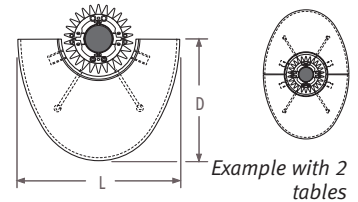

Large shelf

Ø	27.8	31.3	34.8
L	63.7	67.2	70.7
D	31.2	32.9	34.7

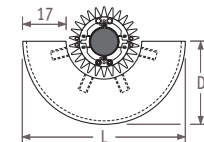

Small shelf

Ø	27.8	31.3	34.8
L	49.7	53.2	56.7
D	24.2	25.9	27.7

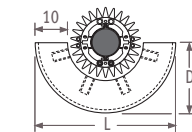

Towel rail

Ø	27.8	31.3	34.8
L	42.7	42.7	49.3
D	22.1	22.1	25.3

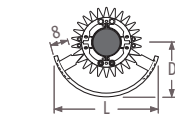

Hat rack

Ø	27.8	31.3	34.8
L	42.7	42.7	49.3
D	22.1	22.1	25.3

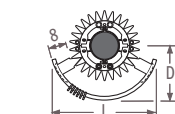

Prices & outputs

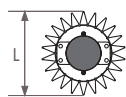

Standard delivery:

- Iguana circo in 2 parts, including all pieces for hydraulic connection
- suspension brackets for mounting around construction column
- guards with opening for valve head
- thermostatic valve 5094.430
- lockshield 5094.431
- 4 chrome-plated air vents G 1/8"
- sleeve couplings: see Connection sets & Valves

Standard colours:

- sandblast grey metallic 001
- white 301(RAL 9010 satin)
- white 333(RAL 9016 satin)

Iguana CIRP

code height length colour conn.
ORDERING CODE: CIRP. 180 027. XXX /MM/CL

H		L 027	031	034
180	75/65/20	1602	1893	2184
	90/70/20	2081	2460	2838
	st. colour	66075	66076	66077
	other			
192	75/65/20	1707	2018	2328
	90/70/20	2211	2613	3015
	st. colour	66078	66079	66080
	other			
200	75/65/20	1773	2096	2418
	90/70/20	2291	2708	3125
	st. colour	66081	66082	66083
	other			
220	75/65/20	1923	2272	2622
	90/70/20	2471	2919	3369
	st. colour	66084	66085	66086
	other			
240	75/65/20	2048	2421	2793
	90/70/20	2617	3094	3569
	st. colour	66087	66088	66089
	other			

Options

Table in beech veneer

CODE	Type	
9087.012660	Circo ø 27	70326
9087.012730	Circo ø 31	70327
9087.012800	Circo ø 34	70328



Large shelf in beech veneer

CODE	Type	
9087.010637	Circo ø 27	70320
9087.010672	Circo ø 31	70321
9087.010707	Circo ø 34	70322



Small shelf in beech veneer

CODE	Type	
9087.011497	Circo ø 27	70323
9087.011532	Circo ø 31	70324
9087.011567	Circo ø 34	70325

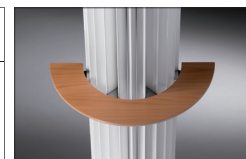

Towel rail chrome-plated aluminium

CODE	Type	
9087.013427	Circo ø 27	70329
9087.013427	Circo ø 31	70329
9087.013493	Circo ø 34	70330



Hat rack chrome-plated aluminium

CODE	Type	
9087.014427	Circo ø 27	70331
9087.014427	Circo ø 31	70331
9087.014493	Circo ø 34	70332



Deco thermostatic head

CODE	Colour	
5090.1111	chrome	14134
5090.1110	chrome / white	14133

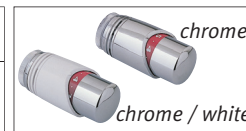

Output measured in accordance with EN442, at a water temperature of 75/65 and a room temperature of 20°C (ΔT=50).

Connection sets & valves
Technical info
Correction factors
Product descriptions
Colours

Page
203
239
243
252
263



21

Iguana Circo Pillar cover